

I KLASSI ÕLI-LIIVAPÜÜDUR NS20

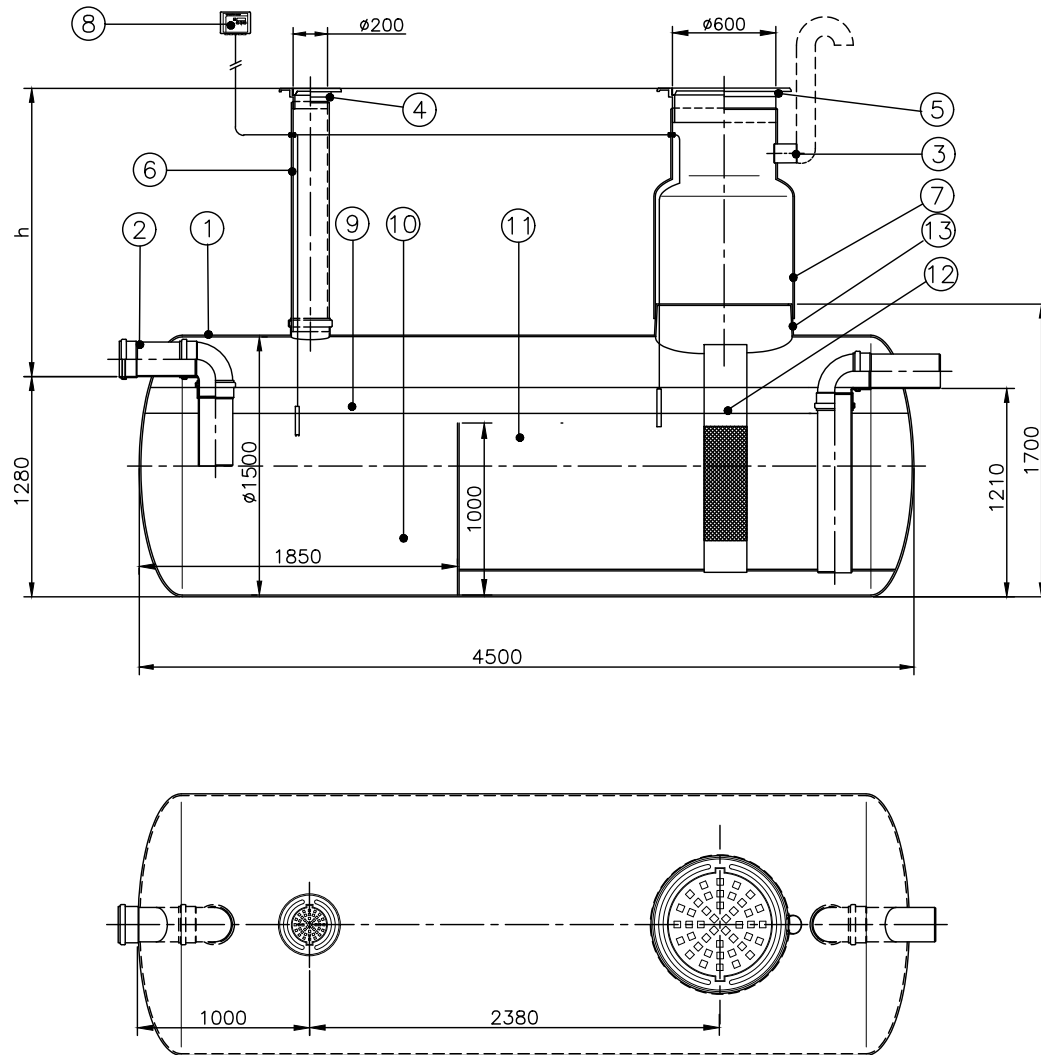

h= _____ mm

1	Püüdiri korpus	klaasplast	Ø1500, L=4500	1
2	Sisend-/väljundtoru	PVC	De200	2
3	Õhutustoru ühenduskoht	PVC	De110	1
4	Luuk	malm	Ø200, 40 t	1
5	Luuk	malm	Ø600, 40t	1
6	Settekambri tühjendustoru	PVC	De200	1
7	Hoolduskaev	klaasplast	Ø800/600	1
8	Alarmseade		õli/liivataseme andur	
9	Õli mahutavus		823 dm ³	
10	Sette mahutavus		2000 dm ³	
11	Kasulik maht		4549 dm ³	
12	Koalisaator			1
13	Sadul hoolduskaevule			1

Joonis: I klassi õli-liivapüüdur NS20 (20l/s)

Novewater OÜ
Polümeri, Sookaera
Kiili vald, Estonia

